

USER'S GUIDE for

HAKITEC[®] 750

**TEMPORARY ROOF with HAKI Trak Sheeting
(Hand-Built)**

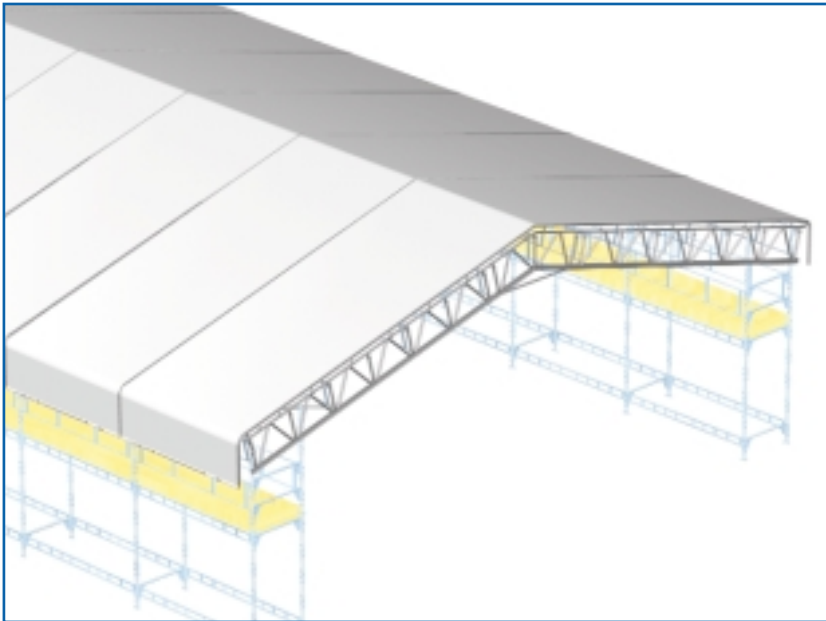

INTRODUCTION

Temporary roof structures are by their very nature amongst the most difficult and demanding scaffolding assemblies.

Whilst HAKITEC750 provides a more efficient alternative to traditional equipment, HAKI believes that only trained and competent operatives should be allowed to erect the system.

Apart from installation of the equipment itself, a SYSTEM requires a SYSTEMISED approach to erection, which may be quite different to previous work methods.

Having the right number of operatives and designating specific work tasks is important to achieving efficiency.

This information incorporates the experience of users throughout the UK. At HAKI, we continually strive for improvement and welcome constructive comments.



WARNING



ALL INFORMATION CONTAINED IN THIS MANUAL APPLIES ONLY TO COMPONENTS MANUFACTURED AND SUPPLIED BY HAKI.

ANY COMPONENTS ORIGINATING FROM OTHER SOURCES WHICH ARE INCORPORATED INTO A STRUCTURE WILL INVALIDATE THIS INFORMATION.

BY MIXING COMPONENTS OF OTHER MANUFACTURE THIS MAY INVALIDATE INSURANCE COVER

GENERAL DESCRIPTION OF SYSTEM

750mm deep Aluminium Alloy Beams laced together with modular Lacing Frames and Plan Braces.

Beams are joined together using 2 steel connecting tubes secured by 8 Spring Clips.

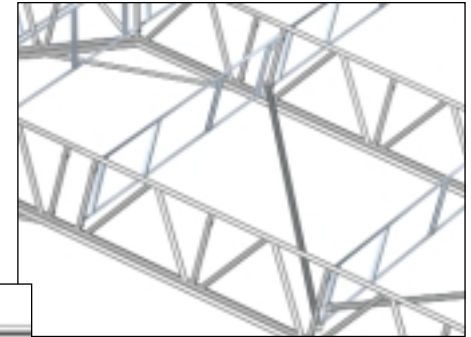

The HAKI Trak system consists of an aluminium alloy extruded track, with integral slots each side, fitted to the top chord of the HAKITEC750 beams with saddles secured by Spring Clips.

Joints in the HAKI Trak units are made using Joiners & Seals and are secured with Joint Plates.

Sheeting is then pulled through the integral slots forming weather resistant roof covering.



GENERAL PRINCIPLES

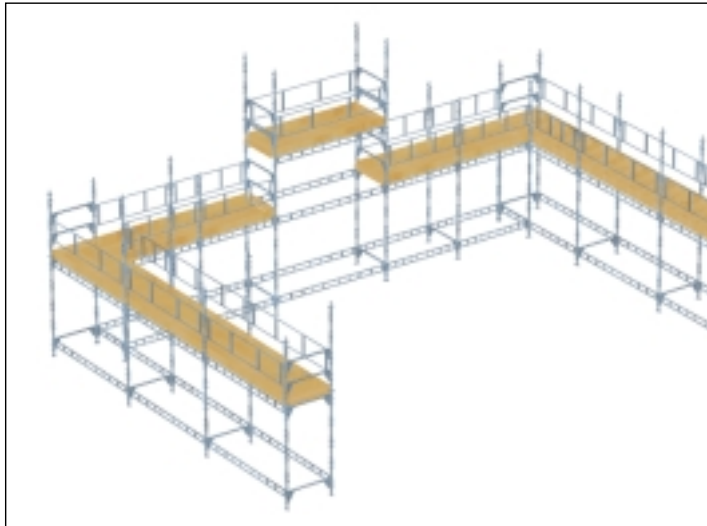

The temporary roof, and supporting structure should be designed by a competent engineer and that the design drawing has considered all appropriate aspects of the roof erection.

All materials are at the work place ready for erection.

The correct number of trained operatives is available. All necessary PPE is available and utilised. All necessary tools are available.

Whenever any operative cannot work from fully guarded platform, he will attach his lanyard to the HAKITEC750 Beam (preferably top chord) when it safe to do so.







One complete set of Walk Boards are available for access to the structure being erected. Side scaffolding prepared in accordance with design drawing ready to receive roof structure.







Note: it is recommended that a boarded platform is provided at a level approximately 1 metre below the bottom chord of the truss where it meets the outside standards.





A gable scaffold should be provided, fully guardrailed on all faces and with adequate access.





If a gable scaffold is not provided, a suitable access platform should be erected from the existing roof to facilitate this erection procedure.







COMPONENTS

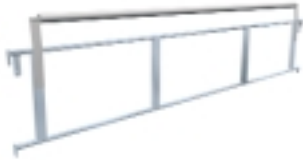

	DESCRIPTION	SIZE	ITEM No.	WEIGHT kg
	FRAME 750 / AL	6.25m	4032625	44.7
	FRAME 750 / AL	3.25m	4032325	23.9
	FRAME 750 / AL	2.25m	4032225	16.6
	FRAME 750 / AL	1.25m	4032125	9.4
	ANGLE FRAME 750 / AL	15°	4202260	18.3
	ANGLE FRAME 750 / AL	22.5°	4202261	17.6
	ANGLE FRAME 750 / AL	37.5°	4202262	16.6

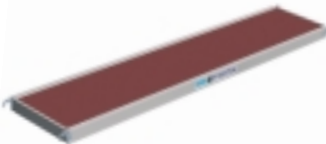
	DESCRIPTION	ITEM No.	WEIGHT kg
	CONNECTOR TUBE 750 G	7203001	2
	SPRING PIN 12mm	2113100	0.1
	SKRD LACING FRAME		
	3.05m	7052301	11.4
	2.5m	7052246	9.6
	1.655m	7052161	7.8
	1.25m	7052121	6.0
	BEAM ADAPTER 750 G	7203325	16.8
	BEAM ADAPTER CLAMP	5231616	2.0
	GUARDRAIL POST 750	7203322	10.3

	DESCRIPTION	ITEM No.	WEIGHT kg
	PLAN BRACE		
	3.05 x 2.25m (L=3.79m) Red	7503022	6.0
	3.05 x 2.0m (L=3.647m) Blue	7503020	5.8
	2.5 x 2.25m (L=3.363m) Green	7502522	5.3
	2.5 x 2.0m (L=3.202m) Gold	7502520	5.1
	1.655 x 2.25m (L=2.793m) Pink	7501622	4.4
	1.655 x 2.0m (L=2.596m) Orange	7501620	4.2
	1.25 x 2.25m (L=2.574m) Black	7502126	4.1
	1.25 x 2.0m (L=2.358m) Brown	7502125	3.8
	HAKI Trak		
	6.25m	7541625	12.9
	3.25m	7541325	6.7
	2.25m	7541225	4.7
	1.25m	7541125	2.6
	HAKI Trak RIDGE		
	15°	7541015	2.8
	22.5°	7541022	2.8
	HAKI Trak END TRACK		
	15°	7541150	3.3
	22.5°	7541220	3.3

	DESCRIPTION	ITEM No.	WEIGHT kg
	HAKE Trak CLAMPS		
	SADDLE TYPE	7541000	0.5
	COUPLER TYPE	7541001	1.0
	END BRACKET	7541002	1.25
	HAKE Trak JOINER	7540001	0.035
	HAKE Trak SEAL	7540002	
	HAKE Trak JOINT PLATE	7540000	0.16
	HAKE Trak RIDGE ROLLER FRAME		
	3.05m	7500021	22.1
	2.5m	7500020	19.9
	1.655m	7500019	14.5
	1.25m	7500018	8.9

	DESCRIPTION	ITEM No.	WEIGHT kg
	750 ERECTION BRACKET	UK7500025	4.8
	WALK BOARD ERECTING HOOK	UK4052002	1.8
	750 WALKING BOARD		
	2m	7500004	14.5
	2.25m	7500005	16.3
	HAKE Trak SHEETING BAR		
	3.05m	7500006	6.8
	2.5m	7500007	5.5
	1.655m	7500026	3.6
	1.25m	7500012	2.7
	HAKE Trak PULLING DEVICE		
	3.05m	7500008	8.0
	2.5m	7500009	7.0
	1.655m	7500028	6.0
	1.25m	7500011	5.0
	HAKE Trak EAVES ROLLER BRACKET	7500010	7.4

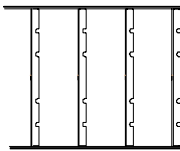
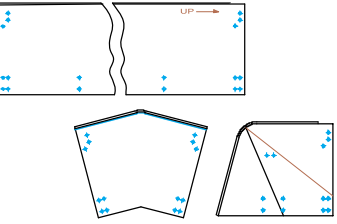
	DESCRIPTION	ITEM No.	WEIGHT kg
	HAKI Trak TENSION BAR		
	3.05m	7500015	6.2
	2.5m	7500014	4.8
	1.655m	7500027	3.3
	HAKI Trak TENSION TUBE		
	3.05m	7500022	13.3
	2.5m	7500023	9.2
	1.655m	7500029	5.9
	RATCHET FIXING STRAP	7540003	0.5
	HAKI Trak SHEETING	7542###	0.7kg/sqm
	HAKI Trak PELMET SHEETING		
	6.25m	7542104	4.4
	3.25m	7542103	2.3
	2.25m	7542102	1.6
	1.25m	7542101	1.0
	RIDGE	7542105	1.0
	END	7542106	1.0

ASSEMBLY OF FRAMEWORK

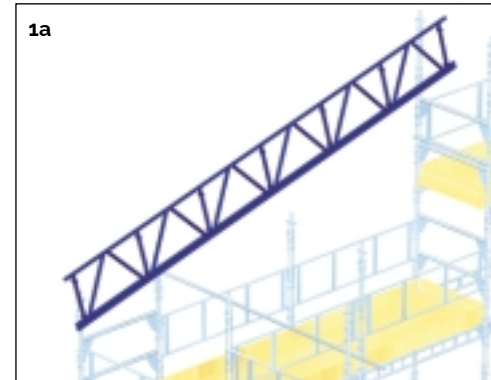

TRUSS 1

Stage 1

Supported on ledge (or Beam Adaptor, depending on design) at side scaffold, position half the truss (without Ridge Frame) and temporarily fix to the rear edge of the gable scaffold.



Fit Ridge Frame. Then level - adjusting the top temporary fixing to suit.

Joints in Beams are effected with Connector Tubes (2 per joint) and retained in position with Spring Pins (8 per joint)

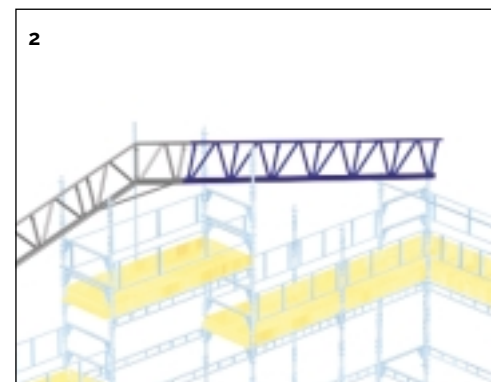

Stage 2

Position other half-truss from opposite side scaffold and fit to Ridge Frame.

Stage 3

Loosen temporary fixings at ridge and position complete truss, resting on side supports.

TRUSS 2

Stage 4



A horizontal tube is connected to the table lift standards immediately under Truss 1.

Ensure the tube protrudes from the front edge for Truss 2 to rest upon during subsequent erection.

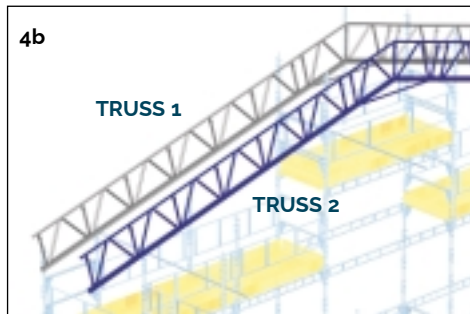

Then Repeat Stage 1.

Stage 5

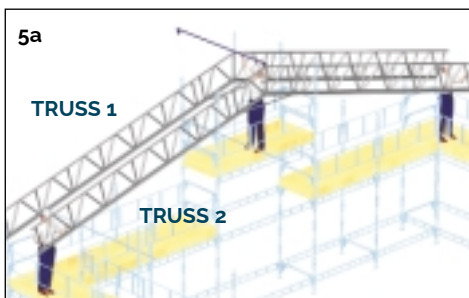

Operative at gable will fit Single Guard Rail into top pocket of Ridge Frame of Truss 2.

As operatives at both side scaffolds manoeuvre Truss 2, operative at gable will control the ridge with Single Guard Rail and push the truss to the required position.

The Single Guard Rail is then fitted into the top pocket of Ridge Frame of Truss 1. (This rail will be replaced at a later stage)

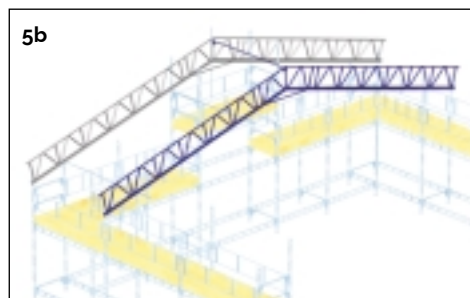

Whenever leaving a safe working platform, it is essential that a Safety Harness be worn with a Double Lanyard clipped off to the top chord of the Aluminium Beam.

Clips must NEVER be attached to LACING FRAMES.

IMPORTANT

ENGAGE LOCKING CATCHES AS EACH COMPONENT IS FIXED.



BAY 1

Stage 6

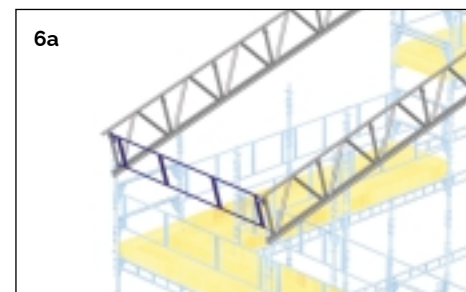

From side scaffold, fit vertical lacing frame at end pockets at both eaves to set truss spacing.



Fit next Lacing Frame (2m from first).

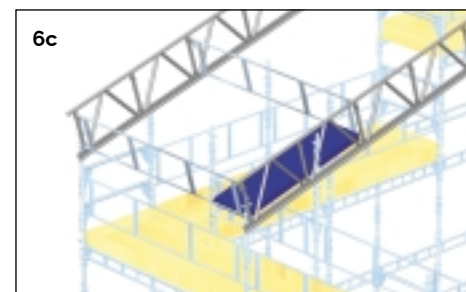

Place Walking Board onto bottom chord of Lacing Frame alongside Truss 2.

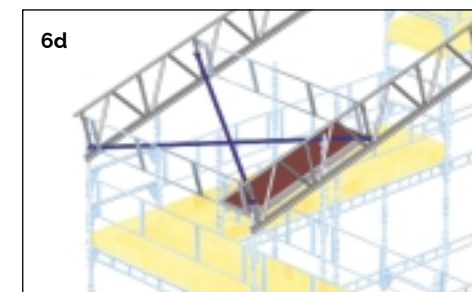

Fit crossing pair of Plan Braces into this bay. These will ensure that the first bay is square.

Note: One of these may be removed later.



For operative feeding materials (feeder) to operatives working on beams (climbers), it is necessary to progressively place Walk Boards on bottom chords of lacing frames adjacent to truss line.

The feeders will attach a Fixed Lanyard (no longer than 800mm) to the adjustable Running Line fixed to the top chord of the Truss.



Adjustable Running Line

Clips must NEVER be attached to Lacing Frames

Stage 7



Whilst clipped on to the Beam, the feeder attaches the fixed end of the Running Line to the top chord of the beam.



The climber proceeds to the next Lacing Frame position and attaches the progressive end of the Running Line to the nearest Vertical Stiffener behind him. The feeder now fully tensions Running Line.



By attaching his short Lanyard to the Running Line the feeder can now carry the next Lacing Frame and pass it to the climber.

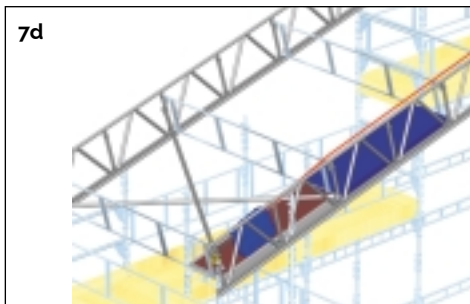

The second Walking Board is now fitted. The feeder then returns to the eaves and attaches his normal Lanyard to the beam, releasing tension on the Running Line (in accordance with manufacturers' instructions). The climber moves to his next position taking the end with him and re-attaches. Then re-tension the line.

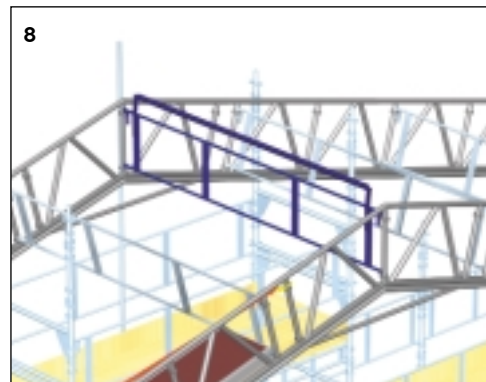

8

Stage 8

When climbers reach ridge, the Single Guard Rail is removed and replaced by a Ridge Roller Frame.

Repeat for other half of roof.

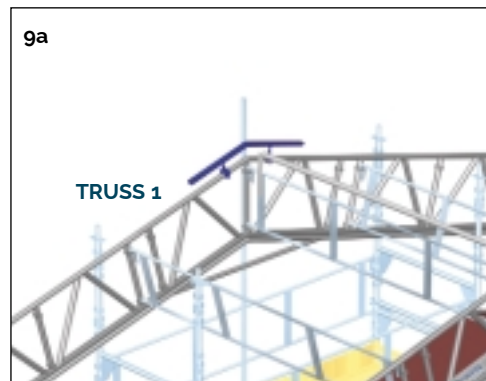

9a

Stage 9

Slide Saddle Clamps into HAKI Trak sections and finger tighten the nuts.

At Truss 1, fit HAKI Trak ridge unit centrally on Ridge Frame and secure with Spring Pins. Tighten nuts with 22mm open-ended spanner.

Prepare next HAKI Trak section by adding joint plate, joiner and seal.

Working from the gable scaffold, progressively fit remaining HAKI Trak units to Truss 1.

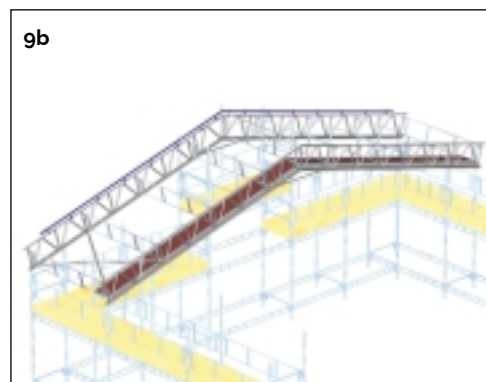

9b

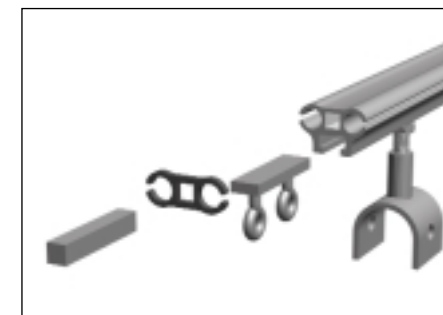

USER'S GUIDE for HAKITEC® 750 TEMPORARY ROOF with HAKI Trak Sheeting

It is essential that a Coupler Type Clamp is fitted adjacent to the eaves on all HAKI Trak roof structures.

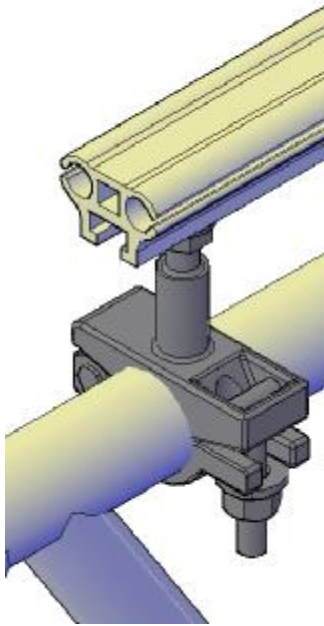

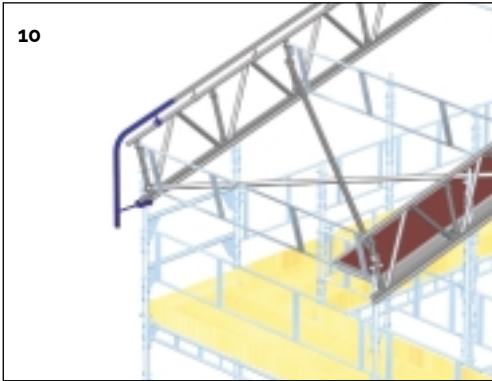

10

Stage 10

At eaves, fit HAKI Trak End Track and End Bracket (secured using Spring Pins).

Fix Truss to side scaffolds.
(depending on design)

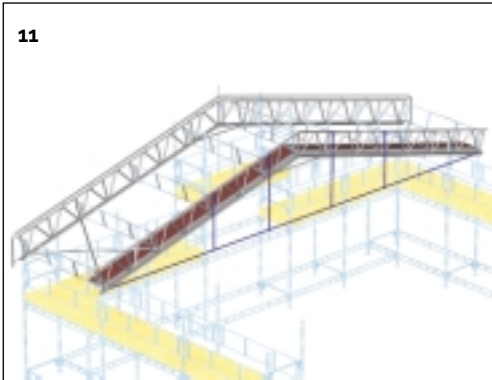

11

Stage 11

If design requires Knee Braces, these should be fixed at this stage.

If the design required Eaves Ties, then these can be safely fixed by operatives experienced in standard procedures for suspended scaffolding.

Remember, always clip to Aluminium Beam.

Note: This bay will be fully braced at a later stage.

BAY 2

This bay is framed out as per Bay 1 stages 6 - 8 except the running line is now not adjusted and access is via the Walking Boards previously erected.

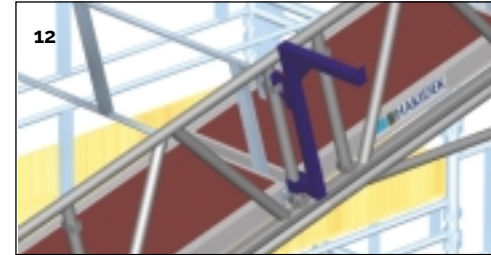

12

Stage 12

Ridge operative will now work from previously erected Walk Board at ridge of TRUSS 2.

The erection bracket is connected to vertical member to enable TRUSS 3 to rest upon during connection sequence.

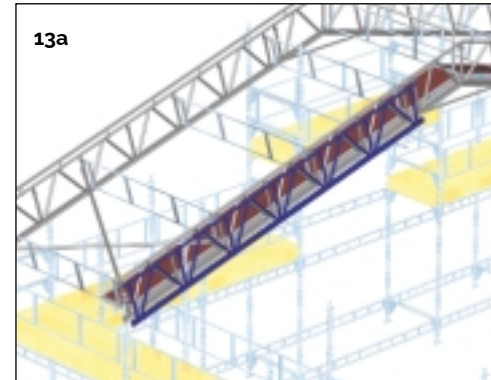

13a

Stage 13

Supported at sides, slide half-roof truss (without Ridge Frame) and support on the erection bracket.

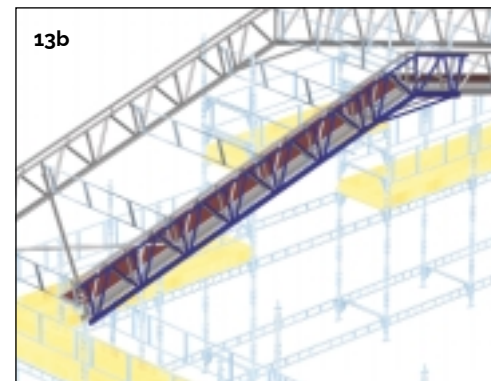

13b

Fit Ridge Frame.

Beams are joined together with Connector Tubes (2 per joint) and retained in position with Spring Pins (8 per joint).

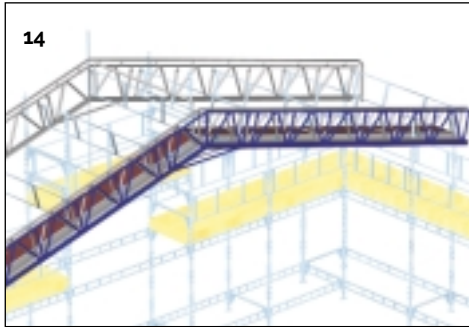

Stage 14

Slide other half-truss from opposite side scaffold and fit to Ridge Frame.

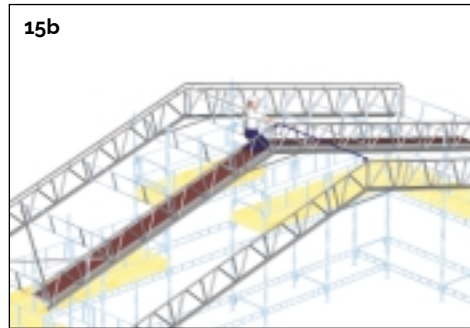
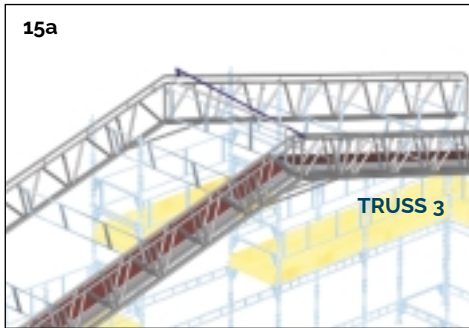

Stage 15

Operative at ridge will fit Single Guard Rail into top pocket of Ridge Frame of Truss 3.

As operatives at both side scaffolds manoeuvre Truss 3, operative at ridge will control the truss. When at the required position, the Single Guard Rail is fitted into the top pocket of Ridge Frame of Truss 2. (This rail will be replaced at a later stage)

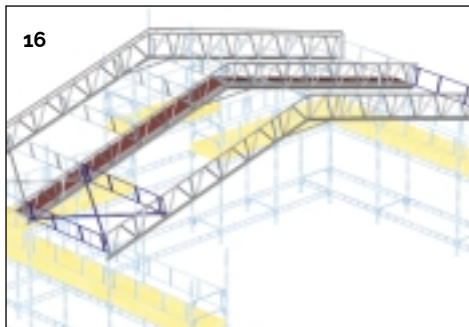

Stage 16

Repeat Stages 6 - 11.

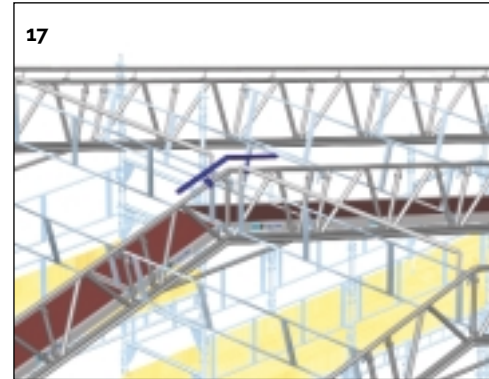

Trak sections are fixed to Truss 2 (see stage 9) **but** working from Walking Boards.

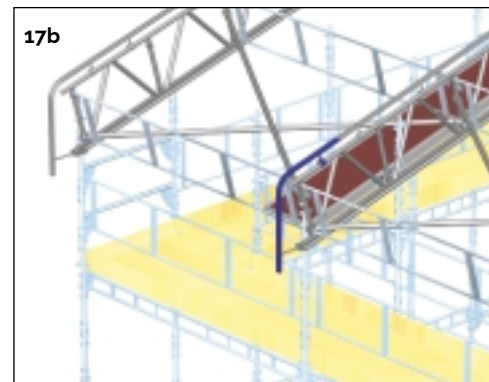
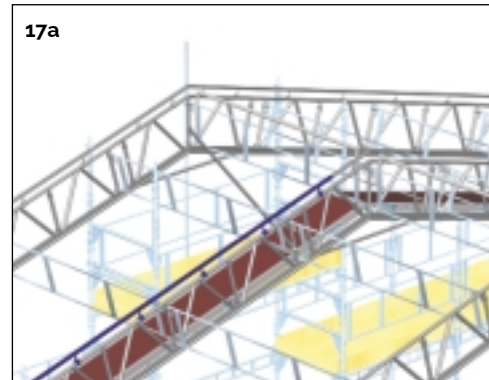

WALKBOARD MOVEMENT AND PLAN BRACE SEQUENCE

Note: Plan Braces will only be fitted to those bays specified by design drawing.

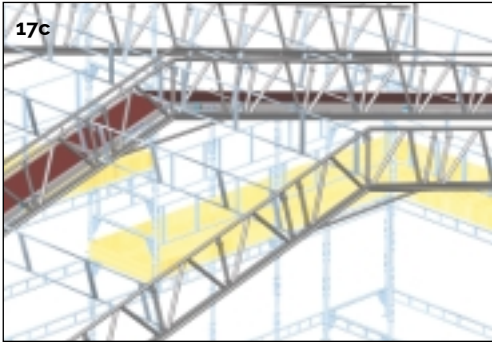

Move uppermost Walking Board to next bay (from Bay 1 to Bay 2).

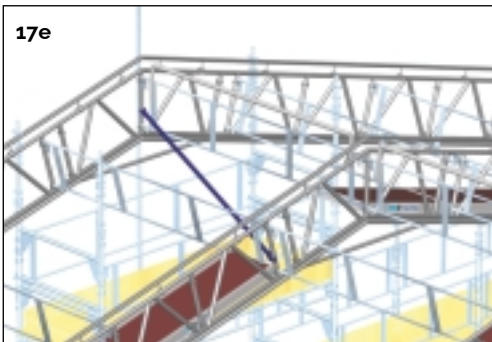
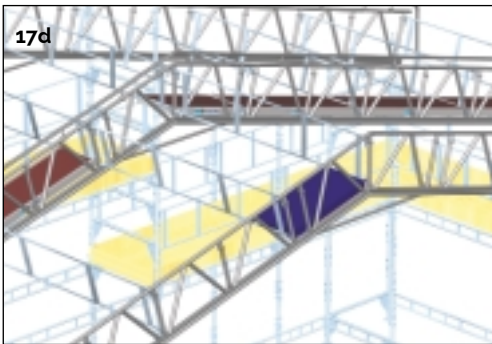

Fit Plan Brace in Bay 1.

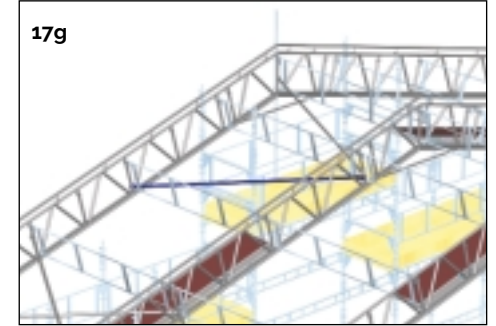
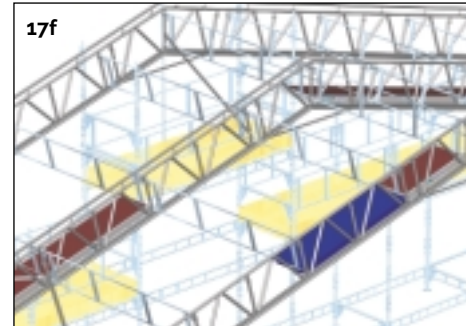

Successively, move walking boards from Bay 1 to Bay 2 and fit Plan Brace behind.

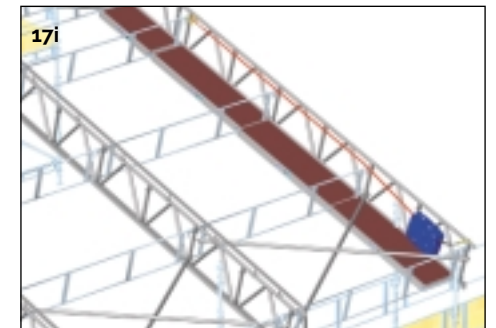
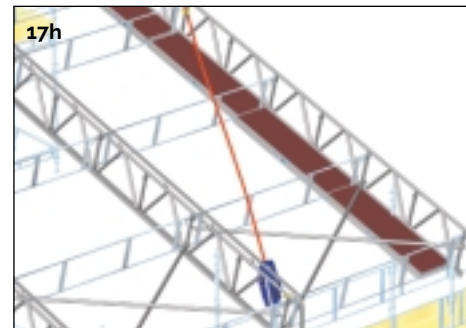

Move Running Line to next Truss.

Note: Repeat stages 16 - 17 for entire length of roof.

SHEETING

IMPORTANT

Prior to sheeting, ensure that any additional equipment to comply with design drawing is installed.

eg, Knee-Braces, Ties, Anchors, Counterweights etc.

From appropriate safe locations at side scaffold

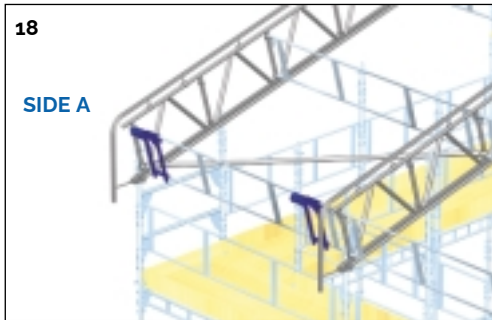

Figure 18

Fit pair of Eaves Roller Brackets to end Lacing Frames at each side of roof.

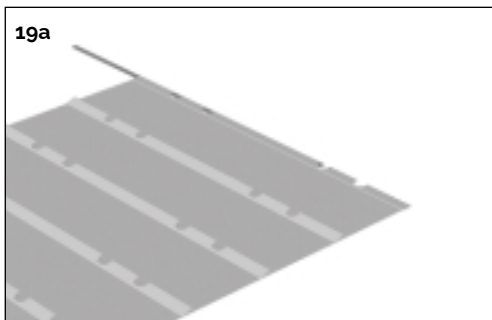
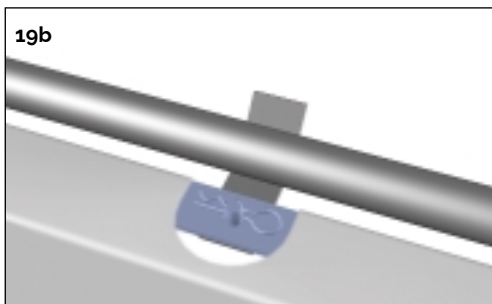

Figure 19

Arrange for a pair of ropes (of sufficient length) to be laid over the complete bay of roof.

Position sheet at one side (A).



Thread Sheeting Bar through sheet pocket and attach to Pulling Device.

Attach ropes to pulling device and take up slack (from opposite side - B).

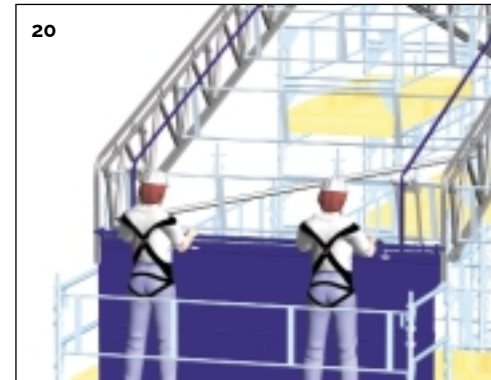

Thread Sheeting Bar through sheet pocket and attach to Pulling Device.

Attach ropes to pulling device and take up slack (from opposite side - B).

As ropes gently pulled, locate wheels of Pulling Device and feed end of sheet into open end of track.

Continue to pull sheet until only 100 to 300mm of sheets remains outside HAKI Trak at Side A.

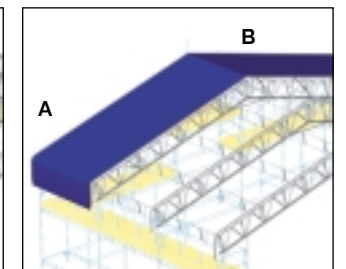
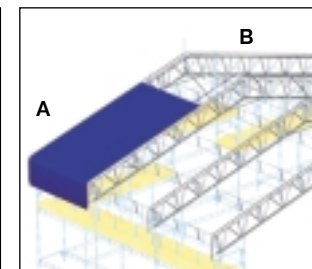
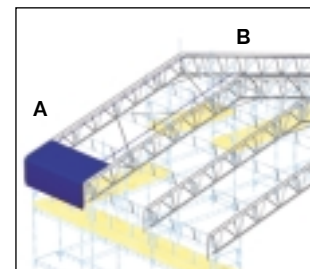
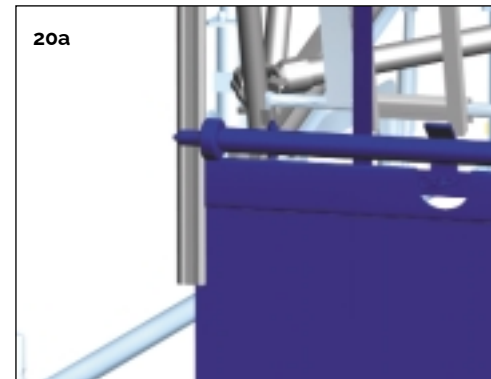

Continue to pull sheet until only 100 to 300mm of sheets remains outside HAKI Trak at Side A.

Note:
Remove Eaves Roller Brackets from both sides.

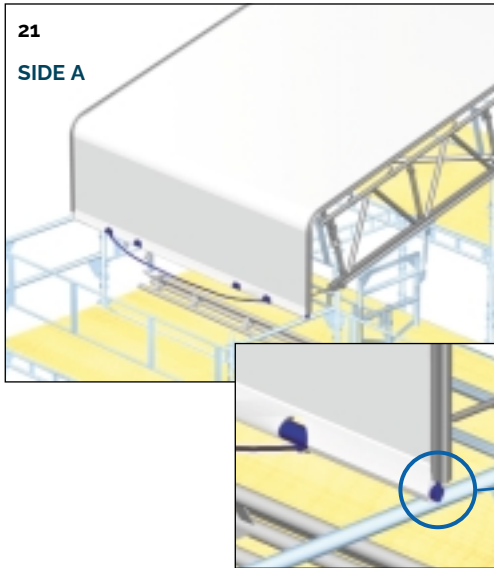

Stage 21

At side A,

Fit Tension Bar through sheet pocket.

Sheet pulled such that Tension Bar locates into end of HAKI Trak at side A.

Fit ratchet strap between loops on tension bar to retain inside sheet pocket.

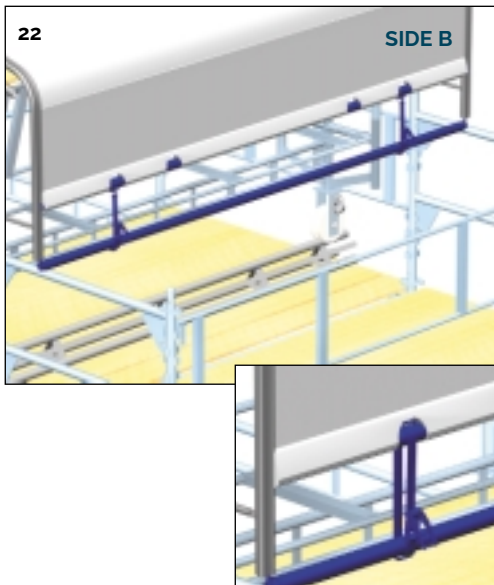
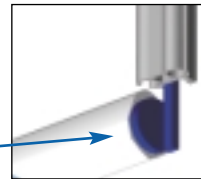

Stage 22

At side B,

Remove Pulling Device & Sheeting bar.

Thread Tension Tube through sheet pocket.

Fit Ratchet Straps around Tension Tube AND Tension Bar located through loops.

Locate Tension Bar in end of HAKI Trak.

Tension the sheet using the Ratchet Straps between the tubes.

Note:
It is important that the sheet is fully tensioned.

SHEET INFO

Pelmets

Fit Ridge Pelmet and fix to Ridge Frame vertical using Cable Tie (or similar).

Slide next full pelmet sheet with cut-out edge uppermost.

Mate pelmets together so that overlapping flap is downward. Fix through common eyelets using Cable Ties (or similar). Repeat for all pelmet sheets along side of gable.

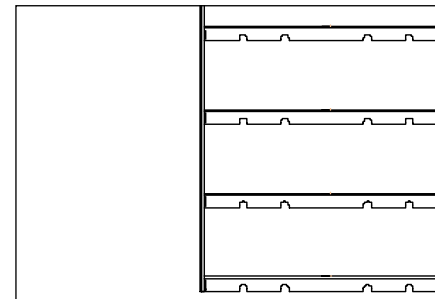
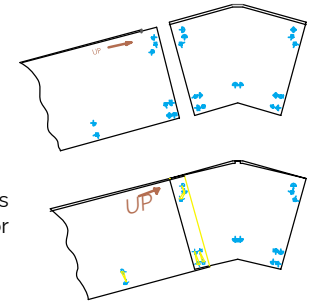

HAKI Trak Sheet

Base fabric: polyester
Coating: flexible pvc both sides
Weight: 610 gms/sq.m

Temperature resistance: - 20°C
Flame retardant to BS.5438 2A
(No flame or after glow)

TECHNICAL INFO

750 Beam

Mean Weight = 7.5 kg/m

Permissible Bending Moment = 41.3 kN.m
(Ultimate = 68 kN.m)

Permissible Shear Force = 30.6 kN
(Ultimate = 50kN)

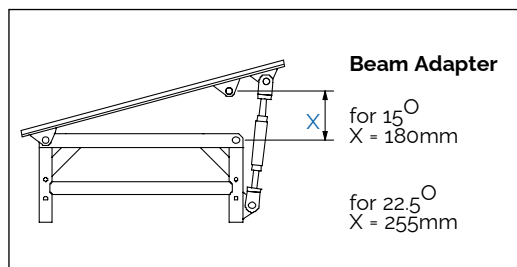
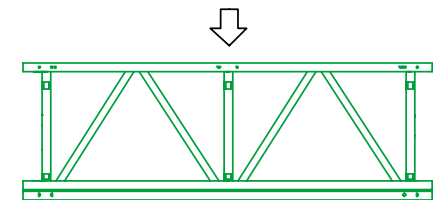

Beam Adapter

for 15°
X = 180mm

for 22.5°
X = 255mm

HAKI Trak

Weight = 2.1 kg/m

Permissible Bending Moment = 1.33 kN.m
0.93 kN.m at joint

Permissible Concentrated Load = 13 kN





BE SAFE – BE SURE

SAFETY CHECKLIST

Before commencing erection

1. Have you got a copy of the design drawing?
2. Is supporting scaffold completed in accordance with the design and ready to receive the roof ?
3. Is the correct equipment on site?
4. Is the equipment in good working order?
5. Have you got the right tools?
 - Tape Measure
 - Rope
 - 22mm Open Ended Spanner

Only carry tools necessary for the job in hand
6. Have you got the appropriate safety equipment?
 - Fixed length, double lanyard harness
 - Rescue procedure in place
 - Walk Boards
 - Running Line (adjustable)
7. Have you considered?
 - number of erectors
 - designated tasks
 - starting position for erection
 - distribution of equipment

Health and Safety at Work Act, 1974

HAKI equipment is designed to meet the requirements of the above Act, Section 6.

It is also the customer's responsibility to comply with the requirements of this Act, particularly to use the equipment in accordance with current codes of practice and in ensuring that components are in good working condition prior to each use.

We are able to provide assistance and advice on matters relating to safe and proper use of HAKI equipment.



SPECIALISTS IN SCAFFOLDING AND WEATHER PROTECTION SYSTEMS

HAKI Ltd. Magnus, Tame Valley Industrial Estate, Tamworth, Staffordshire B77 5BY

Phone: (01827) 282525 **Fax:** (01827) 250329

info@haki.co.uk **www.haki.co.uk**